

For a High Static Pressure Region
DC Axial Fan
Fixed Blade Type
G1751M



$\phi 172 \times 150 \times 51$
($\phi 6.8'' \times 6.0'' \times 2.0''$)
Max. airflow: 11.2 m³/min
Max. static pressure: 840 Pa
Mass: 820 g

Fan model code

- G1751M24B5ZP-00
- G1751M24B6ZP-00
- G1751M24B7ZP-00
- G1751M24B8ZP300
- G1751M24B9ZP300
- G1751M48B5ZP-00
- G1751M48B6ZP-00
- G1751M48B7ZP-00
- G1751M48B8ZP-00
- G1751M48B9ZP-00

High static pressure fans suitable for cooling densely assembled equipment.

Standard specification

Max. airflow		Max. static pressure		Noise dB	Speed min ⁻¹		Voltage spec. V		Current mA		Model code	Operating Temp. Range°C
m ³ /min	CFM	Pa	inH ₂ O		Max.	Min.	Rating	Operating Range	Rating	Starting		
11.2	395	780	3.13	74(7.9m ³ /min)	6800	3200	24	16-28	4800	6900	G1751M24B9ZP300	-20 ~ +60
		840	3.37				48	36-60	2500	6000	G1751M48B9ZP-00	
10	353	710	2.85	71(7.9m ³ /min)	6200	2600	24	16-28	3600	5100	G1751M24B8ZP300	
							48	36-60	1800	3500	G1751M48B8ZP-00	
9.2	325	580	2.33	69(6.7m ³ /min)	5600	2000	24	12-27.6	2850	6100	G1751M24B7ZP-00	
							48	36-60	1360	2650	G1751M48B7ZP-00	
8.3	293	490	1.97	66.5(6.1m ³ /min)	5100	1500	24	12-27.6	2250	3800	G1751M24B6ZP-00	
							48	36-60	1040	2100	G1751M48B6ZP-00	
7.3	258	360	1.45	63(5.3m ³ /min)	4500	1500	24	12-27.6	1500	2800	G1751M24B5ZP-00	
							48	36-60	700	1400	G1751M48B5ZP-00	

- Figures in the table are average measured values. Please request the product delivery specification when preparing a purchase specification.
- The characteristics are the values at rated voltage (24 V, or 48 V), and normal temperature and humidity.
- Max. CFM and max static pressure points conclude at max rotational speed.

General specification

Materials Used	Venturi: Aluminum alloy die castings Propeller: ABS and PBT synthetic resins Bearing: Both side shielded ball bearing
Motor	Brushless DC motor, Protection type: Overcurrent detection and automatic resetting by current limiting
Common Elec. Spec.	See pages G-11, G-12, G-13.
Standard Carton	12 to a carton of (450 x 380 x 220) mm, mass 11 kg

Mounting hole dimensions in mm (inches)
[Recommendation]

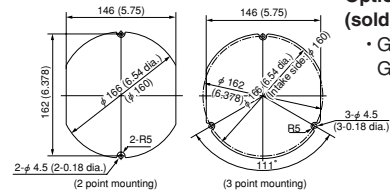

Standard airflow and static pressure characteristics (At rated voltage)
[By double chamber method]

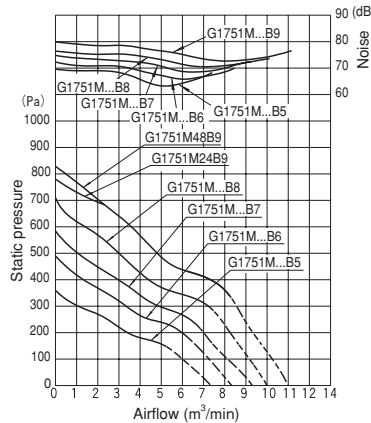

External dimensions in mm (inches)

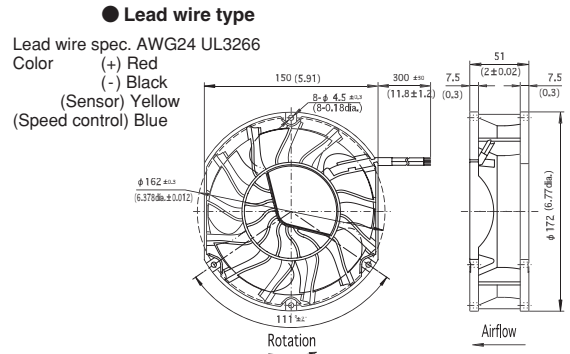

Speed performance (At rated vol., Free air condition) Specification (Room temperature)

CASE 1
• I out 1mA Max.
• V out 5V Max.
• V Losat 0.5V Max.
FREQUENCY 500Hz-5kHz

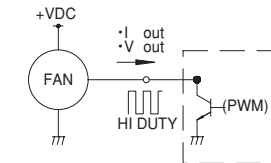

CASE 2
• I out 1mA Max.
• I in 1mA Max.
FREQUENCY 500Hz-5kHz

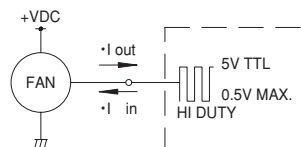

PWM speed control specification (At rated voltage)

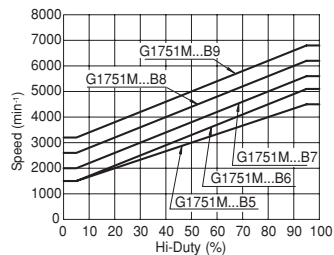

- NIDEC SERVO can meet many of your requirements for customization, such as special connectors, other sensors not listed above, variable speed specifications, and other modifications. Please contact NIDEC SERVO during your product planning and development stage.
- The listed products are registered in the following overseas standards files, UL/cUL: E48889, TUV: R50004410

F60P Guard (Mass 4 g)

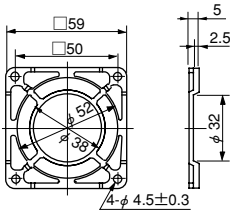

Material: Polycarbonate (black)
UL94V-2

F60UL Guard (Mass 12 g)

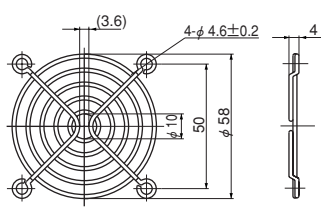

Material: Mild steel wire 1.6 dia.
Surface treatment:
Nickel chromium plating

F80UL Guard (Mass 14 g)

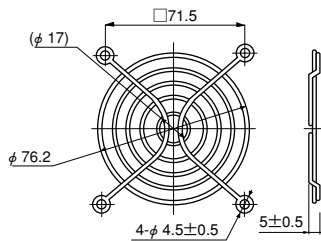

Material: Mild steel wire 1.6 dia.
Surface treatment:
Nickel chromium plating

F92UL Guard (Mass 16 g)

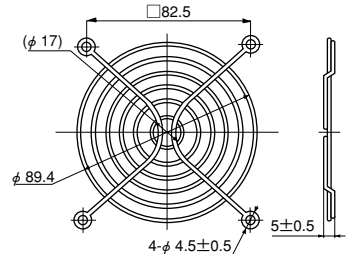

Material: Mild steel wire 1.6 dia.
Surface treatment:
Nickel chromium plating

F120UL Guard (Mass 29 g)

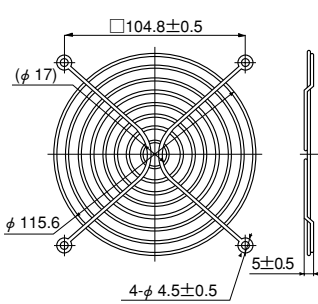

Material: Mild steel wire 1.6 dia.
Surface treatment:
Nickel chromium plating

F127UL Guard

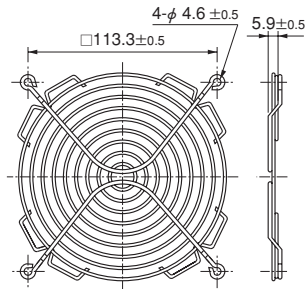

Material: Mild steel wire 1.6 dia.
Surface treatment:
Nickel chromium plating

GUARD 172

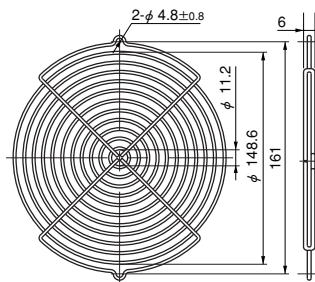

Material: Mild steel wire 2 dia.
Surface treatment:
Nickel chromium plating

F180UL Guard

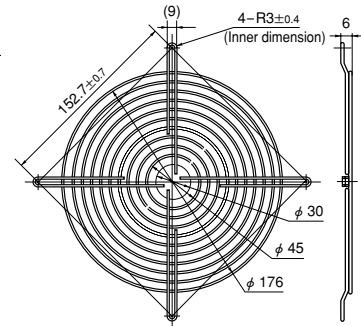

Material: Mild steel wire 1.6 dia.
Surface treatment:
Nickel chromium plating

F200UL Guard (Mass 82 g)

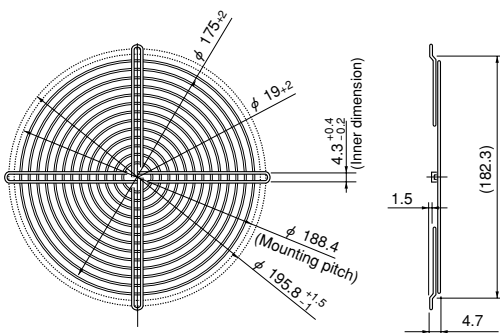

Material: Mild steel wire 1.6 dia.
Surface treatment:
Nickel chromium plating

SCN Guard (Mass 55 g)

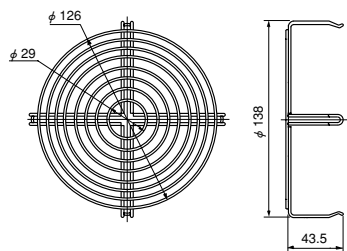

Material: Mild steel wire 1.6 dia.
Surface treatment:
Nickel chromium plating

• Guard special for intake side of
SCN (metal venturi) fans.

List of mating fan series

Guard	F60P	F60UL	F80UL	F92UL	F120UL	F127UL	GUARD 172	F180UL	F200UL	SCN
SCN					○*1					○*2
AC Axial Fans			○	○						
VE			○							
WE				○						
KA				○						
CU					○					
CN					○					
MA							○			
PA							○			
DC Axial Fans	○	○	○	○	○	○	○	○	○	○
TUDC	○	○								
PUDC			○							
KUDC				○						
DO925C				○						
KLDC				○						
CUDC					○					
D1225C					○					
DC Axial Fans										
CNDC					○					
D1238T					○					
D1238B					○					
D1338B						○				
D1338S						○				
D1751M							○			
D1751S							○			
G0638D		○								
G0838C			○							
G0938B				○						
G1238B					○					
G1751M								○		

*1: Can be installed only on outlet side. *2: Can be installed only on intake side.
All guards conform to the UL standard when combined with NIDEC SERVO fans.
The installation of a filter, guard and other accessories will constitute a ventilating load, reducing the airflow. Select a suitable guard, taking into consideration the increase in air resistance. (See Figs. 12 and 13 on page G-7.)

DC axial fans & blowers with sensors

The DC fans and blowers of NIDEC SERVO have a function to send an alarm signal when the fan motor revolutions slow down. Several systems are used to cut off the system power supply by this alarm signal, with three types of sensors available. Select the right type of sensor in accordance with the purpose of use. The lead wire for the sensor is yellow. The output type is an open collector output for all three types.

■ Sensor type

1. Lock detection type (Product code: S)

The output signal indicates an [L] state (transistor is ON) while the propeller is rotating, changing to an [H] state (transistor is OFF) less than five seconds after the propeller stops rotating. The propeller automatically restarts operation within five seconds when the lock is unlocked. ([H] → [L] 5 s). If the pull-up voltage is live, the [H] state (transistor is OFF) will engage in less than five seconds, even when the power is turned off.

- Specification: $V_{CE} = 28\text{ V max}$ (55.2 V max for 48 V products)
 $I_C = 5\text{ mA max}$
($V_{CE(SAT)} = 0.4\text{ V max}$)
- Output waveform

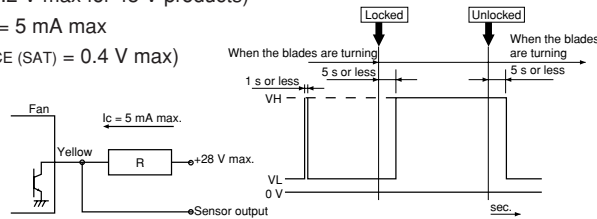

※When the power is turned on, the state sometimes becomes high [H] for several hundred ms.

2. Pulse output type (Product code: P)

A rectangular wave of two pulses will be output for each turn of the propeller while the propeller is rotating, outputting two types of signal depending on the propeller position when the propeller is locked. (See the note below ※)

- Specification: $V_{CE} = 28\text{ V max}$ (55.2 V max for 48 V products)
 $I_C = 5\text{ mA max}$
($V_{CE(SAT)} = 0.4\text{ V max}$)
- Output waveform

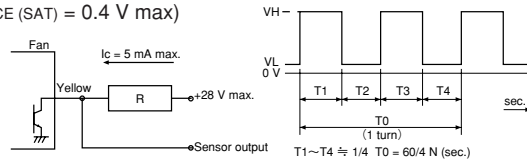

※Output signal waveform when the fan is stopped: The following two types of waveform are output, depending on the blade position when the propeller is stopped:
Pulse outputs of High - constant or restart timing (0.05 Hz to 2 Hz).

3. Speed detection type (Product code: Q)

The output signal indicates the [H] state when the propeller revolutions are slower than the preset speed, changing to the [L] state when the propeller revolutions exceed the reset speed.

[Products with a reversed output waveform are also available, suitable for a wired OR connection when several fans are installed. Contact NIDEC SERVO for further information. {Former code: SQ, new code (15 - digit code products): R}]

- Specification: $V_{CE} = 28\text{ V max}$ (55.2 V max for 48 V products)
 $I_C = 5\text{ mA max}$
($V_{CE(SAT)} = 0.4\text{ V max}$)
- Output waveform

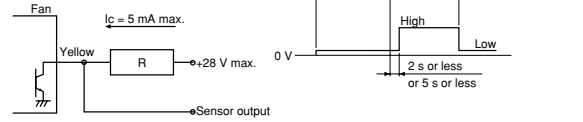

Note: The output waveform for type SQ (R) will be reversed.

The speed setting for the alarm output is about half the rated speed.

For more detailed information, please request a product delivery specification from NIDEC SERVO.

AC fans with sensors

By equipping the motor with a rotation detection function, the AC fans of NIDEC SERVO have a system to send an alarm signal when the fan motor revolutions slow down and to cut off the system power supply. In 1980, NIDEC SERVO developed a system to output an alarm signal by detecting the lowering of generated voltage by installing a tachometer generator with the cooling fan and this system has since been incorporated in NIDEC SERVO products. The output type of the alarm signal is an open collector output.

Type	Tachometer generator type			
Sensor output operation	Open collector transistor, permissible sync Current: 50 mA max. Permissible imposed voltage: DC 40 V max. Permissible power consumption: 1.5 W max. (at 25 °C)			
Sensor output operation	AC power supply	Speed	Output transistor operation	Output state
	OFF		OPEN	HIGH (Abnormal)
	ON	Below detection speed	OPEN	HIGH (Abnormal)
	ON	Above detection speed	CLOSE	LOW (Normal)
Detection speed RD	1500 ~ 2200 rpm			
Detection delay time TD	2 s or less 17 Type			
Type	Standard speed			
Insulation resistance	10 M Ω or higher by a DC 500 V: Between the sensor lead and venturi			
Dielectric strength	Between the sensor lead and venturi	No anomaly allowed after applying AC 500 V 50 Hz for 1 minute		

■ Sensor specification

■ Operational and handling precautions

Operate fans and blowers at an ambient temperature of between -10 °C and 60 °C and relative humidity of less than 90 %. Latch output is not used so malfunction by electrical noise can be ruled out. However, note that the semiconductor devices in the internal circuitry may be damaged by electrical noise and high voltage. No delay circuit is provided so a trouble signal is output on startup. As when operating and handling the fan, exercise caution to avoid dropping and exposing the blower to shock and vibration.

■ Sensor connection

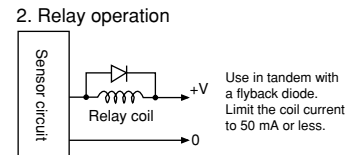
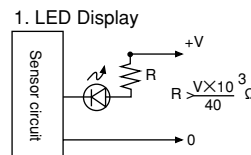

※ A sensor is available with the AS ad PL series only.